

USER MANUAL: Heating element + Heater controller (horizontal) H+h

1 Kit content

Side connection

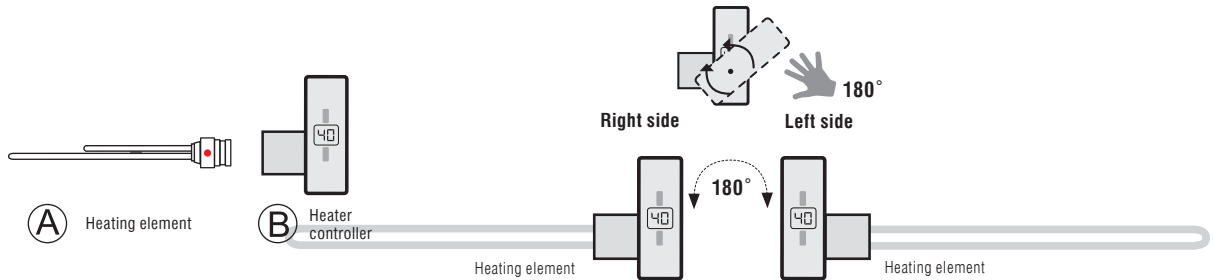

2 Preparing the temperature sensor

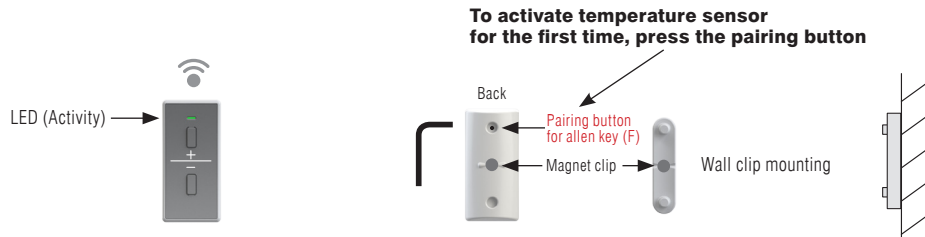

3 Locate suitable place to mount temperature sensor

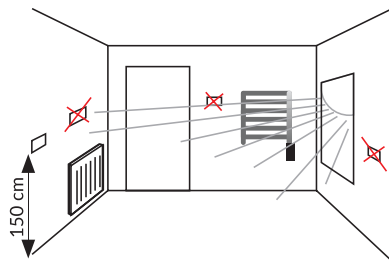

Do not place the temperature sensor:

- over the radiators
- next to doors
- in sunny places

USER MANUAL: Heating element + Heater controller (horizontal) H+h

Central heating system

Electric radiators

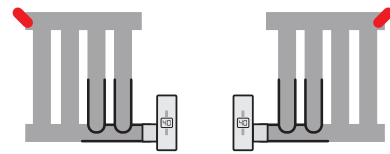
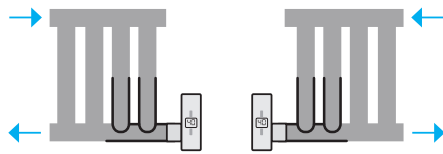

The electric heater must have a safety valve

Installation details

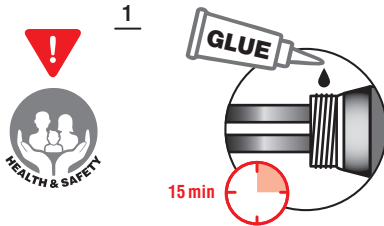

Before you apply the heating element, spread the Loctite glue (included in the set) on the middle of the thread circumference.

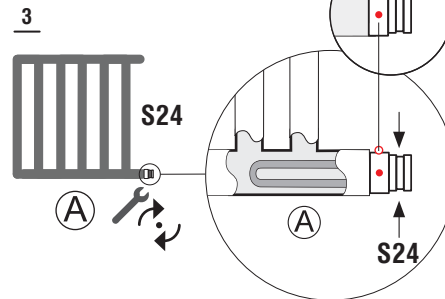
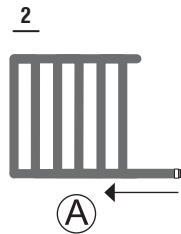
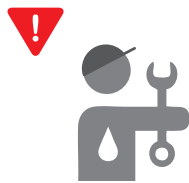

Do not play in yet

Line up dot at front

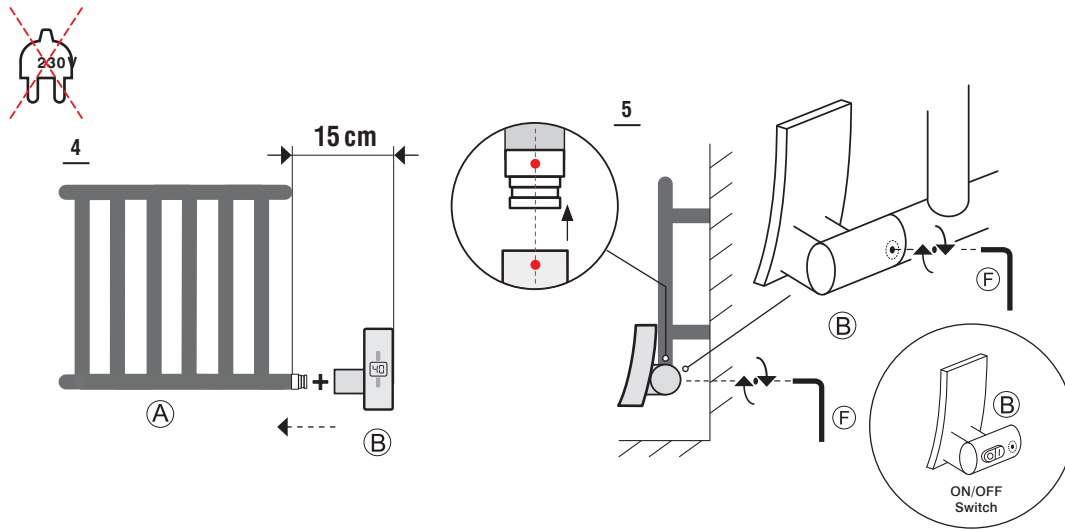

Electric radiators

Central heating system

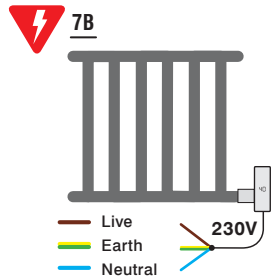
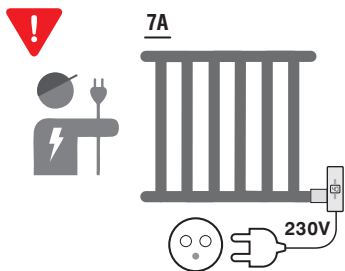
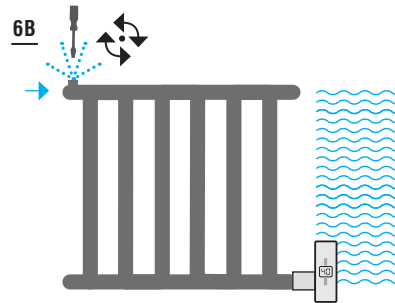
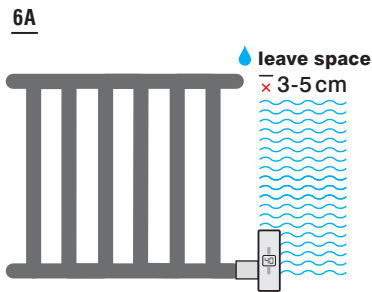

For the heater permanently connected (hard wire) there must be applied a cut-off device from the mains. Such a device must disconnect the heater from the supply mains in 2 poles, with contact separation of at least 3 mm from the main supply

USER MANUAL: WiFi configuration

1 Heater controller



When the heater is connected to the mains properly, the red light will flash on the controller display

2 The heater is ready for WiFi configuration

3 Go to supla.org and create a free supla account and follow the attached instructions.



DOWNLOAD THE APP

SUPLA.ORG





System requirements ANDROID 3.1/IOS 8.2 or the latest version

**Install the application on your devices.
The app will guide you through the individual installation steps.**

